New Engineering Mode

Contents

>> General Information	-----	01
>> Running Data Checking	-----	02
>> Parameter Setting	-----	03

General Information

Running Data Checking

Parameter Setting

Introduction

Operation Instructions

Brief Features

- *Easier Operation*
- *Combined “Data Checking” and “Presetting” functions*
- *Easier data reading in “Data Checking” mode*
- *More parameters for choosing in “Presetting” mode*



General Information

Running Data Checking

Parameter Setting

Introduction

Operation Instructions

Available Products Lines

Y-Design
H+Design

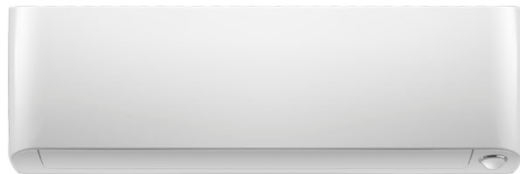

LCAC Series



General Information

Running Data Checking

Parameter Setting

Introduction

Operation Instructions

General Operation

Nothing in 60s

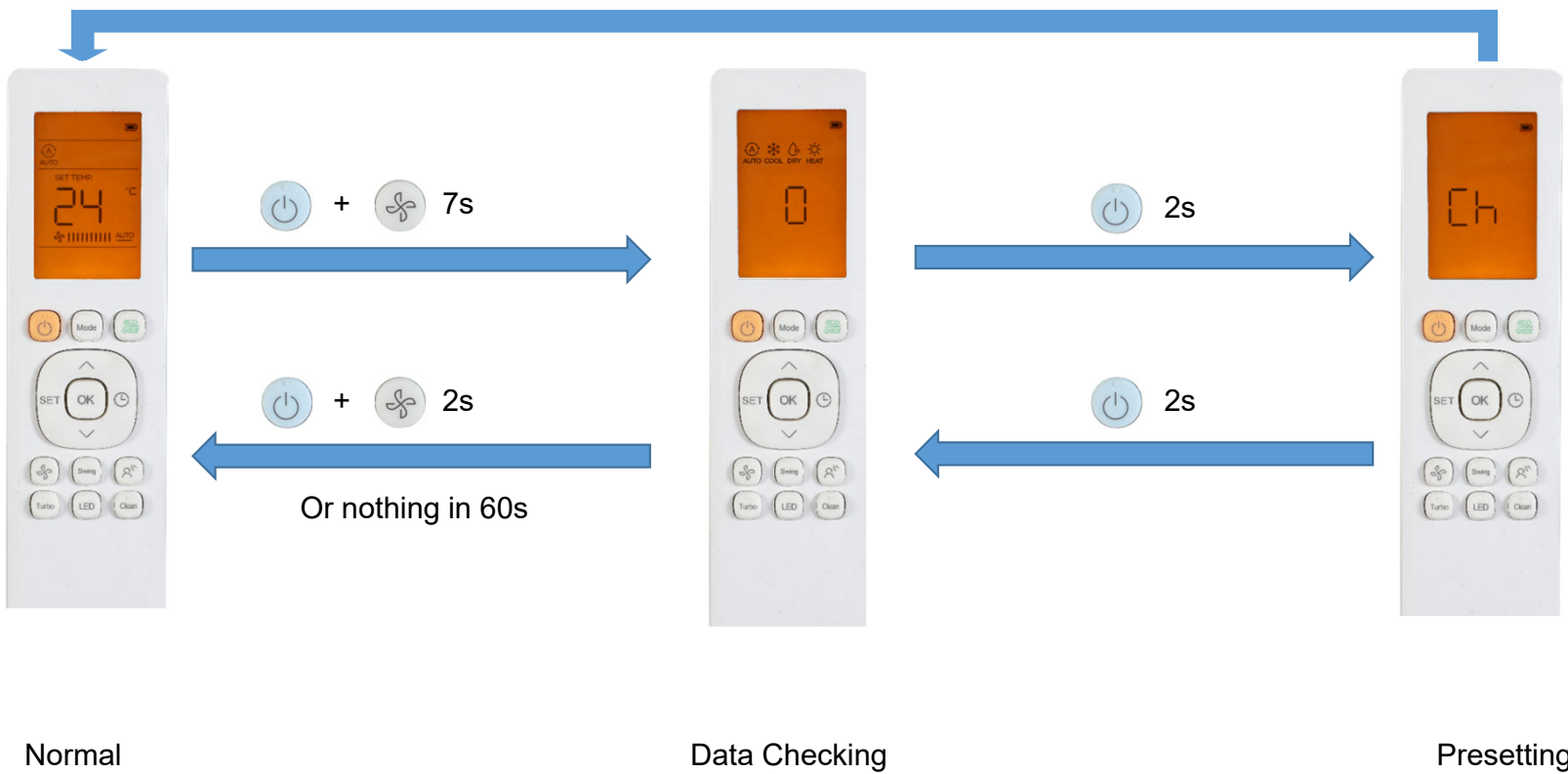

Into Data Checking mode



- 1** Press and hold “Power” and “Fan” buttons for 7 seconds
- 2** Press “Up” or “Down” to check different data

Running Data Checking

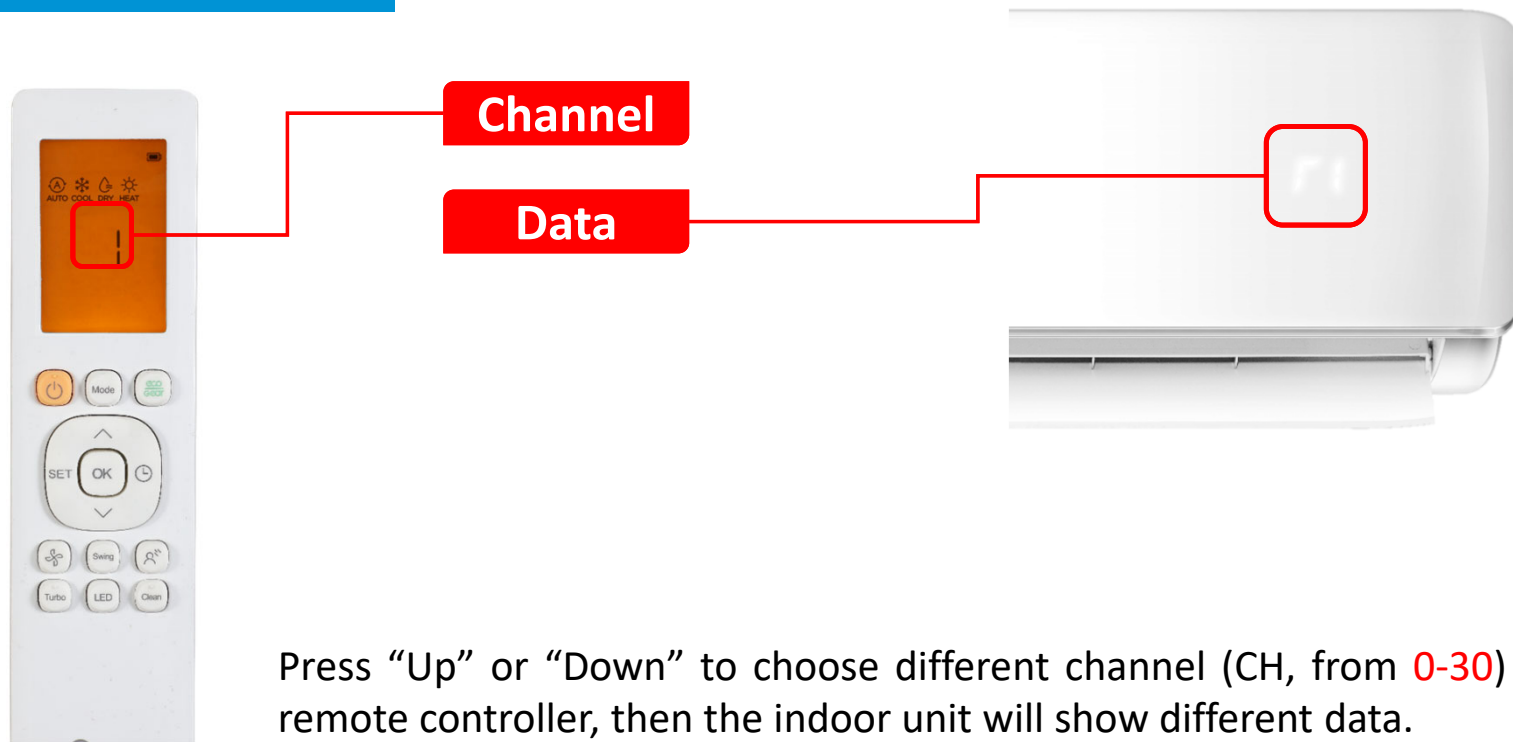

Data Checking List

CH	Code	Meaning	Remark	CH	Code	Meaning	Remark
0		Detailed error code (nA if no error)		16	TT	Set temperature including compensation	Actual data, °C
1	T1	Room temperature	Actual data, °C	17	nA	Reserved	
2	T2	Indoor coil temperature	Actual data, °C	18	nA	Reserved	
3	T3	Outdoor coil temperature	Actual data, °C	19	nA	Reserved	
4	T4	Ambient temperature	Actual data, °C	20	oT	Target Frequency calculated by indoor	Without limitation
5	TP	Discharge temperature	Actual data, °C	21	nA	Reserved	
6	FT	Targeted frequency	Actual data	22	nA	Reserved	
7	Fr	Actual frequency	Actual data	23	nA	Reserved	
8	dL	Running current	3.2A=3	24	nA	Reserved	
9	Uo	Input voltage	220V=22*	25	nA	Reserved	
10	Sn	Reserved		26	nA	Reserved	
11	--	Reserved		27	nA	Reserved	
12	Pr	Outdoor fan speed	Actual data/8	28	nA	Reserved	
13	Lr	EXV opening steps	Actual data/8	29	nA	Reserved	
14	Ir	Indoor fan speed	Actual data/8	30	nA	Reserved	
15	Hu	Humidity (if a sensor there)	Actual data, %				

The indoor unit will show code for 2 seconds, and then the value.

* Some other units will show 22-20, some will show 220.

General Information

Running Data Checking

Parameter Setting

Operation Instructions

Data Explanation

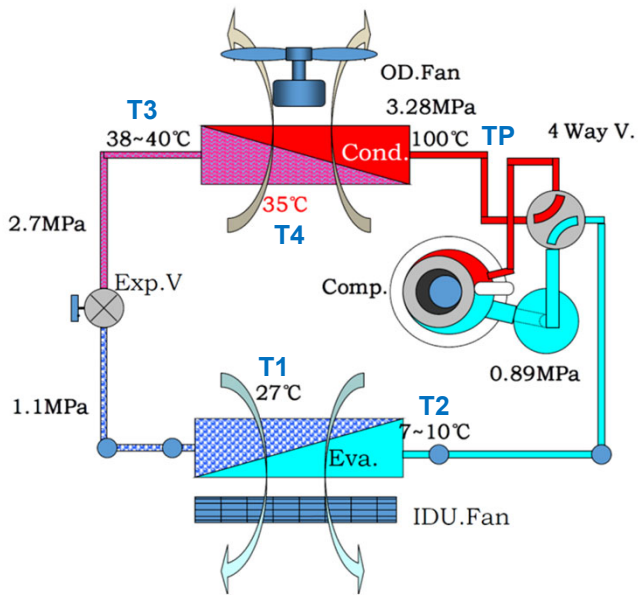

Design Parameters for reference

Items Shown

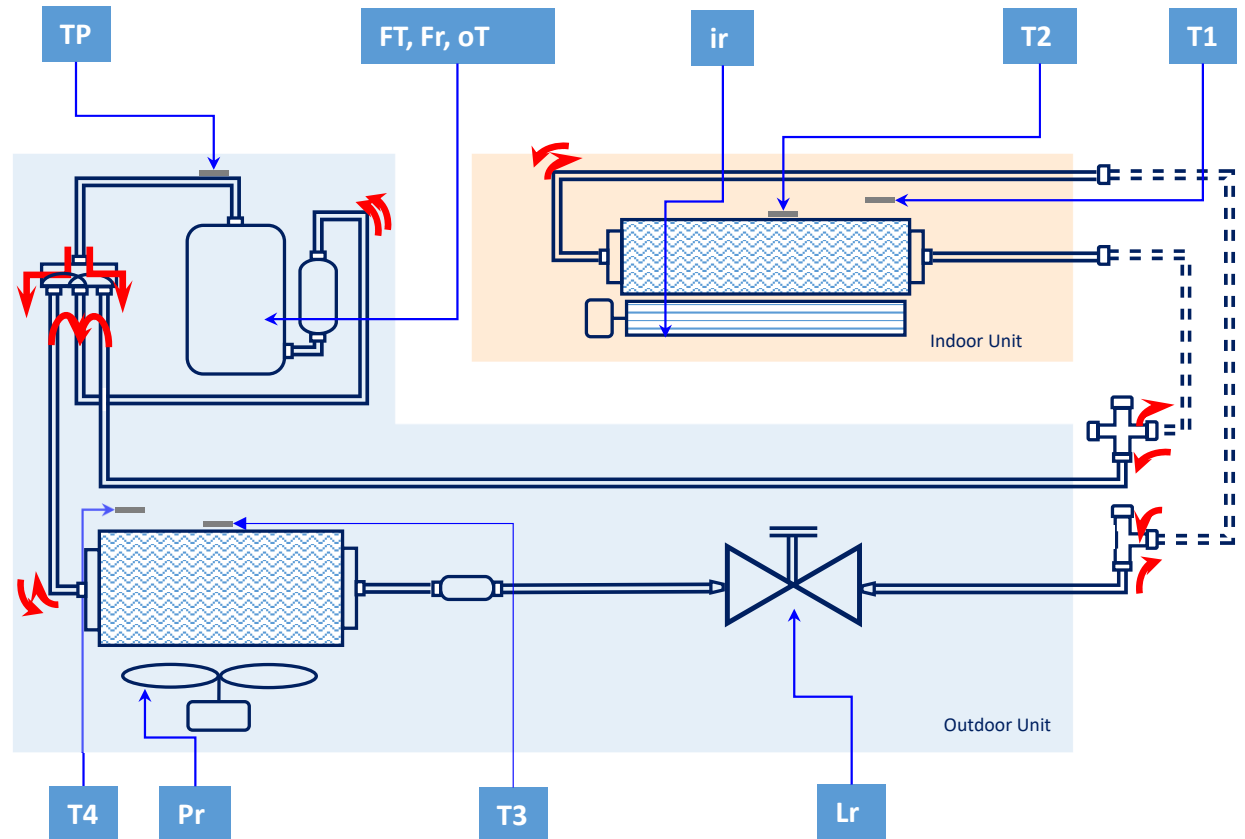

Detailed Error Code (2 digits)

Detailed Code	Meaning	Possible Faulty Part	Normal Error Code
P10	Low DC voltage protection	Outdoor PCB or IPM board	P1
P11	High DC voltage protection	Outdoor PCB or IPM board	P1
P40	Communication error between main control trip and drive chip	Outdoor PCB or IPM board	P4
P41	Error of current sampling circuit of compressor	Outdoor PCB or IPM board	P4
P42	Error of compressor start up	Compressor	P4
P43	Phase lose protection	Connection cable of compressor	P4
P44	Zero speed protection	Compressor	P4
P45	Synchronization error between 341 chip and PWM	Outdoor PCB or IPM board	P4
P46	Compressor speed out of control	Outdoor PCB or IPM board, or compressor	P4
P49	Over current of compressor	Outdoor PCB or IPM board, compressor or refrigeration system	P4

Detailed Error Code (4 digits)

Detailed Code	Meaning	Possible Faulty Part	Normal Error Code
EH 31	DC voltage is too low of indoor DC fan motor (with DC fan driver board)	Indoor PCB or DC fan driver board	EH 03
EH 32	DC voltage is too high of indoor DC fan motor (with DC fan driver board)	Indoor PCB or DC fan driver board	EH 03
EH 33	Over-current protection of indoor DC fan motor (with DC fan driver board)	Indoor PCB, DC fan driver board or indoor DC motor	EH 03
EH 34	IPM protection of indoor DC fan motor (with DC fan driver board)	DC fan driver board or indoor DC motor	EH 03
EH 35	Phase lack protection of indoor DC fan motor (with DC fan driver board)	Connection cable of indoor DC motor	EH 03
EH 36	Current checking circuit faulty of indoor DC fan motor (with DC fan driver board)	DC fan driver board	EH 03
EH 37	Zero speed protection of indoor DC fan motor (with DC fan driver board)	Indoor DC motor	EH 03
EC 55	IPM temperature sensor open circuit or short circuit	IPM temperature sensor	EC 02
EC 71	Over-current protection of outdoor DC fan motor	Outdoor PCB or DC motor	EC 07
EC 72	Phase lack protection of outdoor DC fan motor	Connection cable of outdoor DC motor	EC 07
EC 73	Zero speed protection of outdoor DC fan motor	Outdoor DC motor	EC 07
EC 74	Current checking circuit faulty of outdoor DC fan motor	Outdoor PCB	EC 07
EC 75	IPM protection of outdoor DC fan motor	Outdoor PCB or DC motor	EC 07

Detailed Error Code (4 digits)

Detailed Code	Meaning	Possible Faulty Part	Normal Error Code
EH b5	Communication error between indoor PCB and smart eye	Indoor PCB or smart eye	EH 03
EH 0F	Smart eye fault	Smart eye	EH 03
EH 0L	Display EEPROM fault	Display board	EH 0b
PC 10	Outdoor AC voltage is too low	Power supply or outdoor PCB	PC 01
PC 11	Outdoor DC voltage is too high	Power supply or outdoor PCB	PC 01
PC 12	Outdoor DC voltage is too low (MCE faulty of IR341 chip)	Power supply or outdoor PCB (Outdoor PCB)	PC 01
PC 40	Communication error between main control trip and drive chip	Outdoor PCB or IPM board	PC 04
PC 41	Error of current sampling circuit of compressor	Outdoor PCB or IPM board	PC 04
PC 42	Error of compressor start up	Compressor	PC 04
PC 43	Phase lose protection	Connection cable of compressor	PC 04
PC 44	Zero speed protection	Compressor	PC 04
PC 45	Suddenly power lost	Power wire loses connection	PC 04
PC 46	Compressor speed out of control	Outdoor PCB or IPM board, or compressor	PC 04
PC 49	Over current of compressor	Outdoor PCB or IPM board, compressor or refrigeration system	PC 04
PC 06	High discharge temperature protection of compressor	Lack of refrigerant, blocked condenser (cooling) or blocked evaporator (heating)	

Detailed Error Code (4 digits)

Detailed Code	Meaning	Possible Faulty Part	Normal Error Code
PC 08	Over current of outdoor unit	Power supply, outdoor PCB or blocked refrigeration system	
PH 09	Indoor fan stop because of anti-cold wind function	Lack of refrigerant or blocked refrigeration system	
PC 0F	IGBT fault of PFC circuit	Outdoor PCB	
PH 90	Hi evaporator temperature protection in heating mode	Blocked evaporator or capillary, EXV, or faulty sensor	
PH 91	Lo evaporator temperature protection in cooling mode	Lack of refrigerant or partial blocked capillary, EXV, or faulty sensor	
PC 0A	Hi condenser temperature protection in cooling mode	Blocked condenser or capillary, EXV, or faulty sensor	
LH 00	Frequency limitation caused by high or low evaporator temperature		
LC 01	Frequency limitation caused by high condenser temperature		
LC 02	Frequency limitation caused by high discharge temperature		
LC 03	Frequency limitation caused by high current		
LC 05	Frequency limitation caused by high or low voltage		
LC 06	Frequency limitation caused by high IPM temperature or faulty PFC		
LC 30	Frequency limitation caused by high pressure		
LC 31	Frequency limitation caused by low pressure		
LH 07	Frequency limitation caused remote controller		

Pre-setting when installation

With this mode, you can change some pre-settings such as auto-restart, temperature compensation and so on when installing an air conditioner to make it run more properly for real applications.

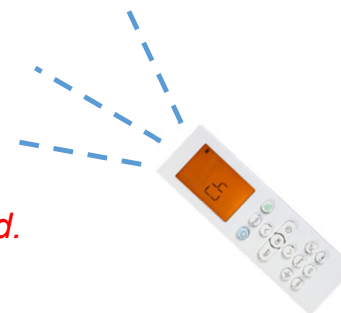
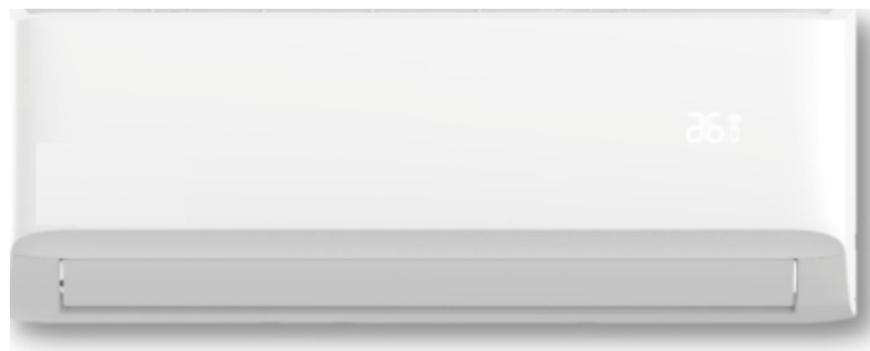

Note:

- *Presetting mode is only valid in 1 minutes when AC unit is first-time electrified.*
- *The AC unit should be off.*

General Information

Running Data Checking

ting

Operation Instructions

Parameter Explanation

Into Parameter Setting



Data Checking

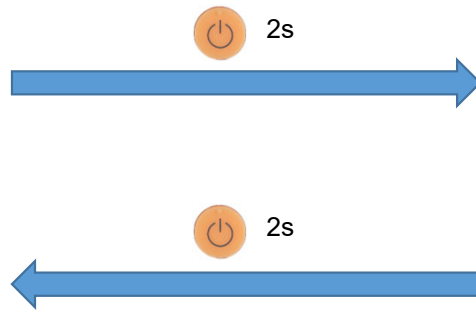

Presetting

Note:
The remote controller should be in data checking mode first.

Press and hold "Power" button for 2 seconds to active presetting function in the channel.

Parameter query



- 1 Press “Up” or “Down” button to choose a channel that you want to query
- 2 Press and hold “Power” button for 2 seconds
- 3 Press “OK” to query current parameter while the remote controller shows “CH”. The parameter will be shown on the indoor unit.

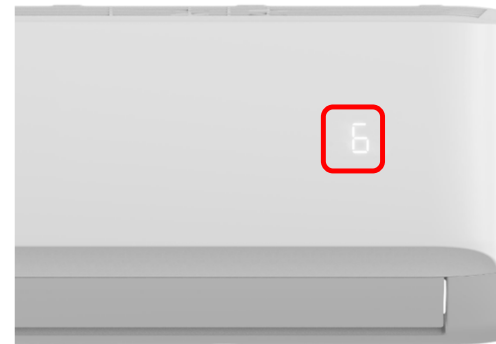

Query Example

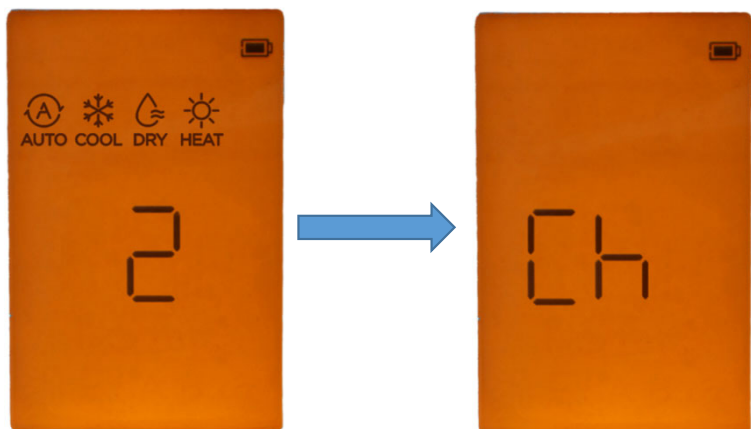

- 1 Press “Up” or “Down” button to choose channel 2 (Fan control when Ts reached)
- 2 Press and hold “Power” button for 2 seconds
- 3 Press “OK” to query current parameter while the remote controller shows “CH”. The parameter will be shown on the indoor unit.
(“6” means the fan will be off for 15 mins and run for 1 min.)



Parameter setting

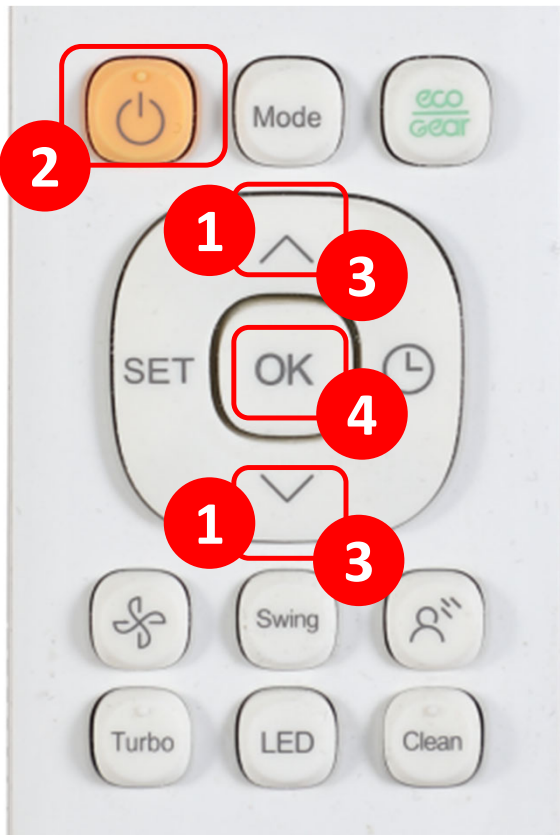

- 1 Press “Up” or “Down” button to choose a channel that you want to set
- 2 Press and hold “Power” button for 2 seconds
- 3 Press “Up” or “Down” to choose the suitable parameter.
- 4 Press “OK” to send the parameter to indoor unit.

The indoor unit will show the parameter sent by the controller to confirm acceptance, and then it will show “88”, which means the program is resetting.

For Example

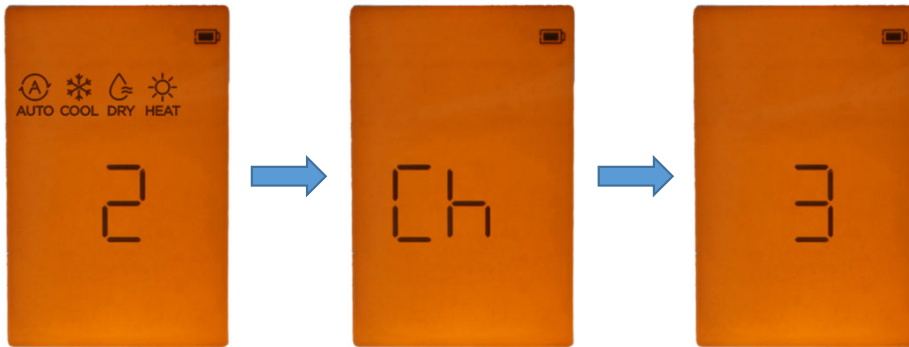

- 1 Press “Up” or “Down” button to choose channel 2 (Fan control when Ts reached)
- 2 Press and hold “Power” button for 2 seconds
- 3 Press “Up” or “Down” to choose 3 (keep in setting fan speed).
- 4 Press “OK” to send the parameter to indoor unit.

The indoor unit will show “3” to confirm acceptance. And then it will show “88”, which means the program is resetting.



Settable Parameter List

CH	Item	Parameter Meaning	Remark
0	/	Nothing to set	
1	Auto-restart function	0 – Inactive 1 – Active	
2	Fan control when Ts reached	1 – Fan stop 2 – Fan runs at lowest RPM 3 – Fan runs at setting RPM 4 – Fan stops for 5 mins and runs for 1 mins 5 – Fan stops for 10 mins and runs for 1 mins 6 – Fan stops for 15 mins and runs for 1 mins 7 – Fan stops for 20 mins and runs for 1 mins 8 – Fan stops for 30 mins and runs for 1 mins 9 – Fan stops for 40 mins and runs for 1 mins 10 – Fan stops for 50 mins and runs for 1 mins 11 – Fan stops for 60 mins and runs for 1 mins	
3	Mode lock	CH – Cooling and heating (all modes) HH – Heating only (Heating + Fan only) CC – Cooling only (Cooling + Drying + Fan only) nU – Cooling and heating without Auto	Remote controller will change as well.

Settable Parameter List

CH	Item	Parameter Meaning	Remark
4	Lowest setting temperature	16-24	Remote controller will change as well.
5	Highest setting temperature	25-30	Remote controller will change as well.
6	Mode priority selection for multi units	H – Heating first C – Cooling first	
7	/	Nothing to set	
8	/	Nothing to set	
9	/	Nothing to set	
10	/	Nothing to set	
11	Min. frequency limitation in cooling mode	10, 11, 12, ..., 49, 50, -- (Cancel)	
12	Min. frequency limitation in heating mode	10, 11, 12, ..., 49, 50, -- (Cancel)	
13	Max frequency selection in T4 limitation of Zone6	20, 21, 22, ..., 149, 150, -- (Cancel)	
14	/	Nothing to set	

Settable Parameter List

CH	Item	Parameter Meaning	Remark
15	Frequency selection of outdoor forced-operation	10, 11, 12, ..., 249, 250, -- (Cancel)	
16	One button reset	rS – Reset	
17	nA	Nothing to set	
18	/	Nothing to set	
19	Max. frequency selection in cooling mode	40, 41, 42, ..., 83, 84, -- (Cancel)	
20	Max. frequency selection in heating mode	40, 41, 42, ..., 83, 84, -- (Cancel)	
21	Cooling temperature compensation	-3.0, -2.5, -2.0, ..., 3.0, 3.5, -- (Cancel)	
22	Heating temperature compensation	-6.5, -6.0, -5.5, ..., 0.5, 1.0, 1.5, ..., 7.0, 7.5, -- (Cancel)	
23	Max. fan speed selection in cooling	-41, -40, -39, ..., 19, 20, -- (Cancel)	Fan speed will add set data*8. <i>It is risk. Do not set it if not necessary</i>
24	Min. fan speed selection in cooling	-41, -40, -39, ..., 19, 20, -- (Cancel)	
25	Max. fan speed selection in heating	-41, -40, -39, ..., 19, 20, -- (Cancel)	
26	Min. fan speed selection in heating	-41, -40, -39, ..., 19, 20, -- (Cancel)	
27	/	Nothing to set	
28, 29, 30	Reserved	Nothing to set	
NOTE	Data in red is not valid for OP series.		